

Article number: 20285B18B122SW

Description: E+G Swivel clamp connector joint
GN285-B18-B12-2-SW

Measures

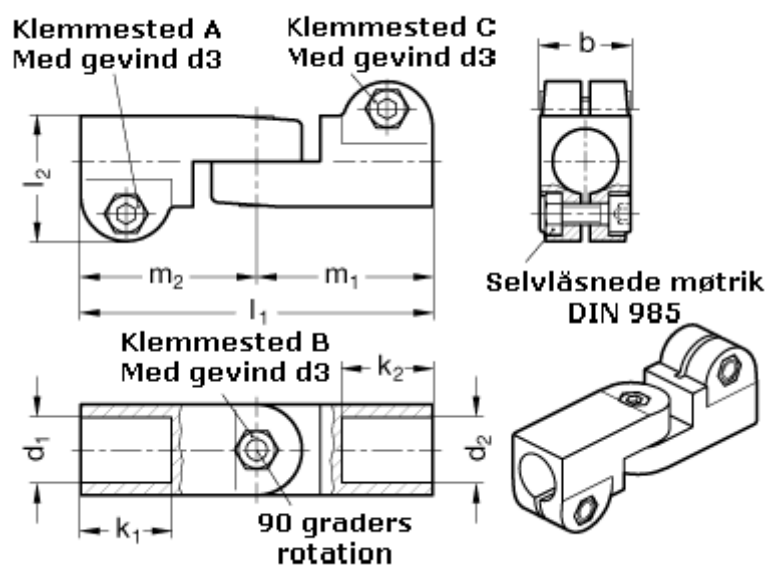

$b = 25$

$m_1 = 48.5$

$d_1 = B18$

$m_2 = 48.5$

$d_2 = B12$

$d_3 = M 6$

$k_1 = 25$

$k_2 = 25$

$l_1 = 97$

$l_2 = 34.5$